

# SUPERIOR 60'

cod. ASSUP60M

2 YEARS\*  
WARRANTY

**EN** Model with steel brackets fastening system. Fire resistant up to 60 minutes (certified). The extractable plunger with adjusting spring allows a comfortable regulation. This product guarantees a 48 dB noise reduction (IFT Rosenheim Certificate).

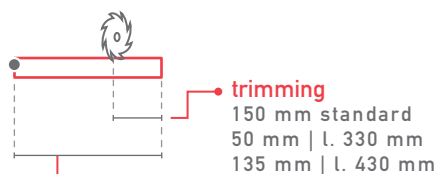

**lengths**

330 430 530 630 730 830 930 1030  
1130 1230 1330 1430 1530 mm

**plunger type**



**certification**

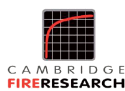

File nr. R39141

**application**

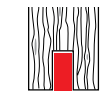

TIMBER  
DOOR



SECURITY  
DOOR

**size 14x35 mm**

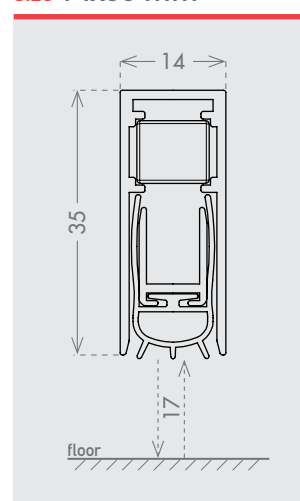

**seals**

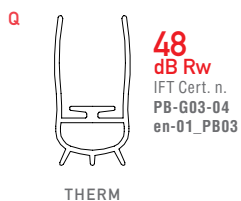

**fixing type**

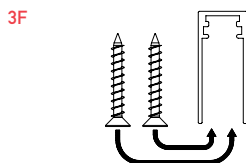
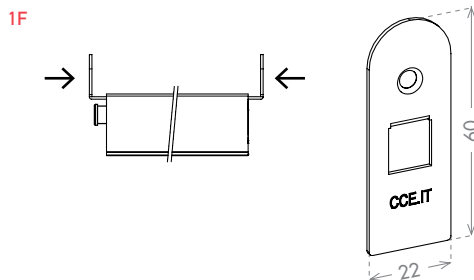

**optional**

**ACTUATOR PIVOT** cod. ACAPIV p. 153

**IT** Modello tradizionalmente fissato con squadrette in acciaio, certificato per tenuta al fuoco fino a 60 minuti. La regolazione è semplice ed avviene tramite pulsante a molla estraibile. Tenuta acustica di 48dB certificata da IFT di Rosenheim.

**DE** Traditionell mit Stahlaschen befestigtes Modell, zertifizierte Brandbeständigkeit bis 60 Minuten. Die Regulierung ist einfach und wird mit einem ausziehbaren Federdruckknopf gewährleistet. Durch IFT Rosenheim zertifizierte Schalldämmung 48 dB.

**FR** Modèle avec un système de fixation traditionnel avec équerres en acier, certifié pour une tenue au feu jusque 60 minutes. Le réglage est simple et se fait via le bouton poussoir extractible sur ressort. Etanchéité acoustique 48dB certifié par IFT Rosenheim.

**ES** Modelo tradicionalmente fijado con escuadras de acero, certificado para resistencia al fuego hasta 60 minutos. El ajuste es sencillo y se realiza con el pulsador de resorte extraíble. Aislamiento acústico de 48 dB certificado por el instituto IFT de Rosenheim.

**RU** Эта модель имеет традиционное крепление стальными скобами и сертифицирована на предел огнестойкости до 60 минут. Регулировка выполняется просто при помощи съёмной пружинной кнопки. Звукоизоляция на 48 дБ сертифицирована институтом IFT г. Розенхайм.